

User Manual

Component

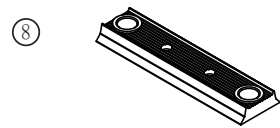
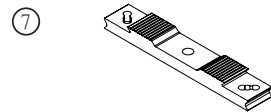
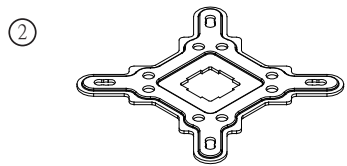
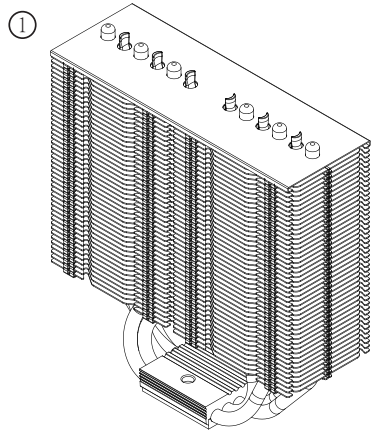

① Armageddon CPU Cooler

② Intel Backplate

③ Rivet Nut

④ O-ring

⑤ Double End Stud with Nut

⑥ Screw Nut

⑦ Aluminum Strip Adapter

⑧ Aluminum Mounting Plate

⑨ Spring-loaded Screw

⑩ ArmaClip™

⑪ Thermal Compound

User Manual

Installation

Step 1

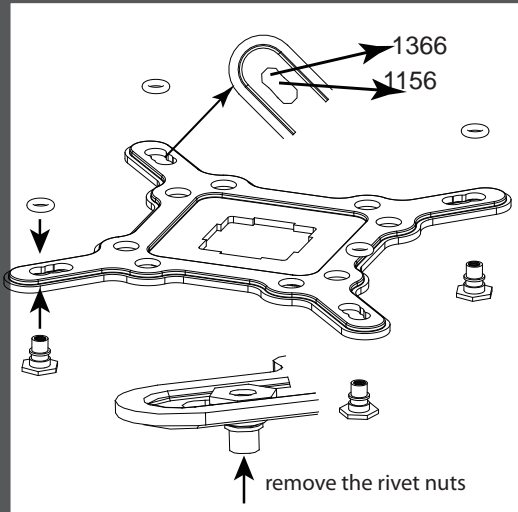

Step 2

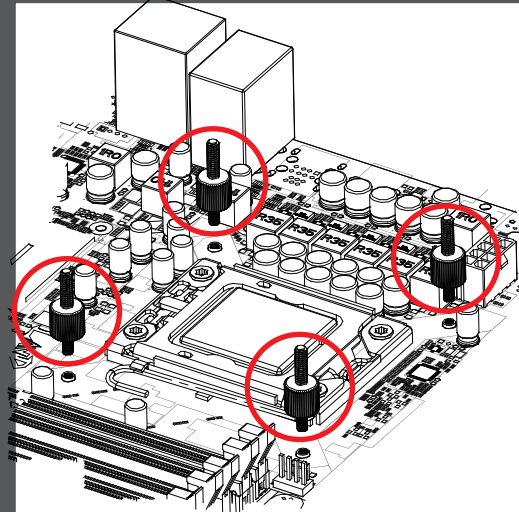

Step 3

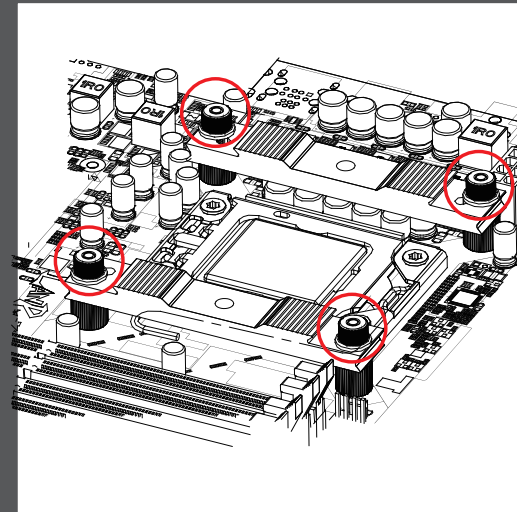

Step 4

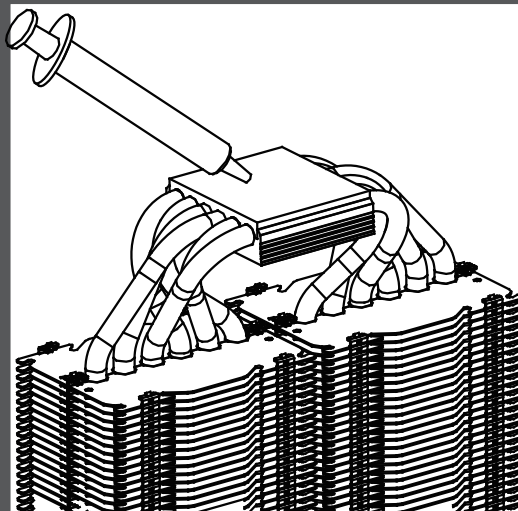

Step 5

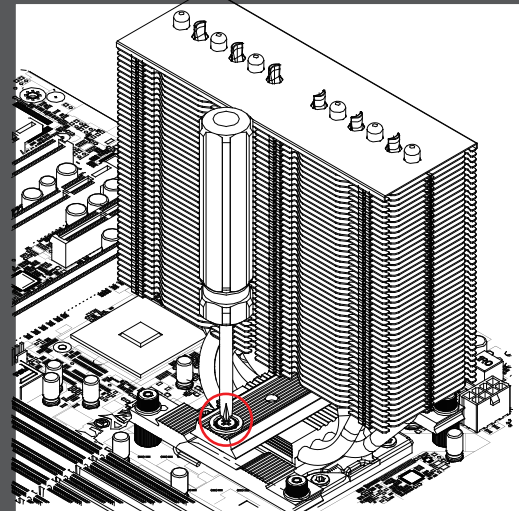

Step 6

